

# Data Sheet



Article number: 5725024204

Description: NSK Ball bearing unit ASPP204  
Pressed steel housing

## Measures

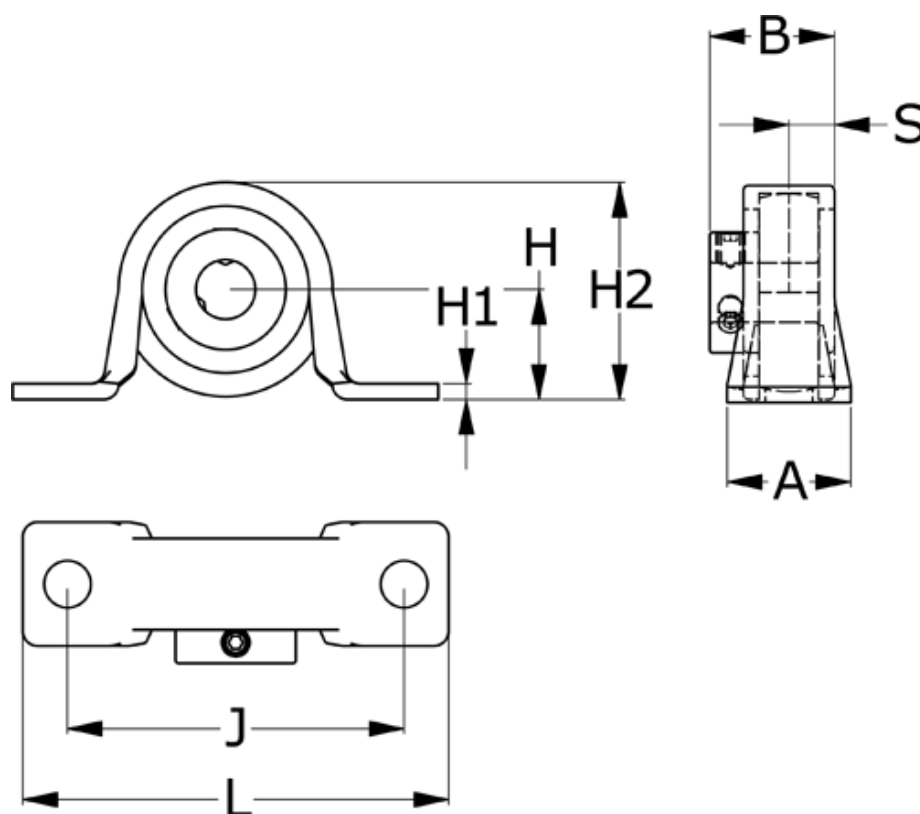

A = 32

B = 25

H = 25.4

H1 = 3.2

H2 = 50.5

J = 76

L = 98

N = 9.5

S = 7

Shaft  $\bar{\text{}}$  = 20